

VALVEXTM
Power of Quality

ONYX valve

**PN 40
180°C**

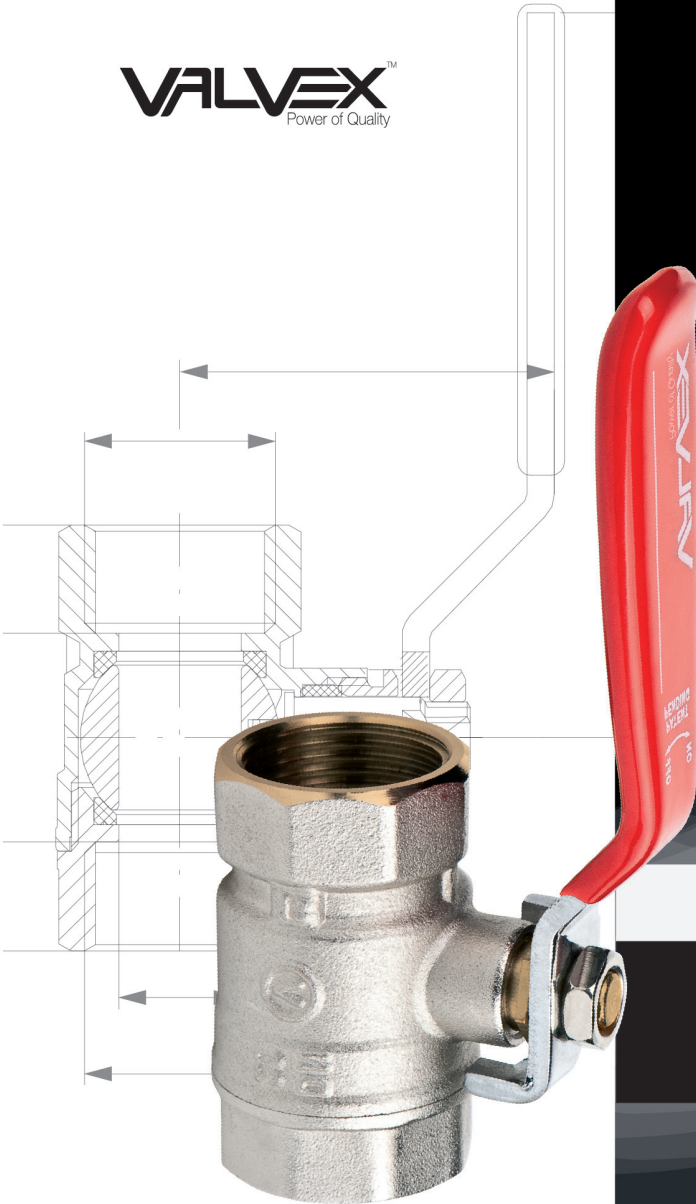

**NICKEL
free**

**POWER OF
QUALITY**





ONYX Full-port ball valve with nut on stem and steel lever (female-female version)

CODE	P nom. / max temp.	SIZE
1451320	PN40, 180°C	3/8"
1452320	PN40, 180°C	1/2"
1453320	PN40, 180°C	3/4"
1454320	PN40, 180°C	1"
1455320	PN30, 180°C	1 1/4"
1456320	PN30, 180°C	1 1/2"
1457320	PN30, 180°C	2"

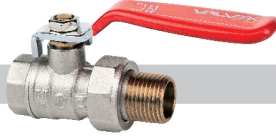

ONYX Full-port ball valve with nut on stem, with tail piece and steel lever

CODE	P nom. / max temp.	SIZE
1452420	PN40, 180°C	1/2"
1453420	PN40, 180°C	3/4"
1454420	PN40, 180°C	1"



ONYX Full-port ball valve with nut on stem and steel lever (female-male version)

CODE	P nom. / max temp.	SIZE
1451460	PN40, 180°C	3/8"
1452460	PN40, 180°C	1/2"
1453460	PN40, 180°C	3/4"
1454460	PN40, 180°C	1"
1455460	PN30, 180°C	1 1/4"
1456460	PN30, 180°C	1 1/2"
1457460	PN30, 180°C	2"



ONYX Full-port ball valve with nut on stem and aluminium butterfly handle (female-female version)

CODE	P nom. / max temp.	SIZE
1452400	PN40, 180°C	1/2"
1453400	PN40, 180°C	3/4"
1454400	PN40, 180°C	1"

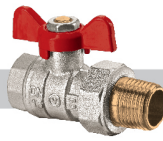

ONYX Full-port ball valve with nut on stem, with tail piece and aluminium butterfly handle

CODE	P nom. / max temp.	SIZE
1452440	PN40, 180°C	1/2"
1453440	PN40, 180°C	3/4"
1454440	PN40, 180°C	1"



ONYX Full-port ball valve with nut on stem and aluminium butterfly handle (female-male version)

CODE	P nom. / max temp.	SIZE
1451480	PN40, 180°C	3/8"
1452480	PN40, 180°C	1/2"
1453480	PN40, 180°C	3/4"
1454480	PN40, 180°C	1"

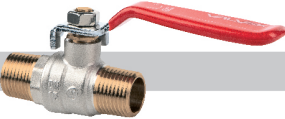

ONYX Full-port ball valve with nut on stem and steel lever (male-male version)

CODE	P nom. / max temp.	SIZE
1452470	PN40, 180°C	1/2"
1453470	PN40, 180°C	3/4"
1454470	PN40, 180°C	1"

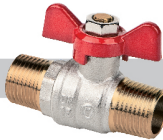

ONYX Full-port ball valve with nut on stem and aluminium butterfly handle (male-male version)

CODE	P nom. / max temp.	SIZE
1452430	PN40, 180°C	1/2"
1453430	PN40, 180°C	3/4"
1454430	PN40, 180°C	1"

VALVEXTM
Power of Quality

Valvex S.A., ul. Nad Skawą 2, 34-240 Jordanów, Poland
tel. +48 18 269 32 20, 269 32 49, fax +48 18 269 32 11
e-mail: valvex@valvex.com

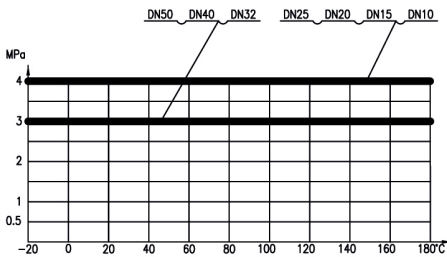

operating characteristic

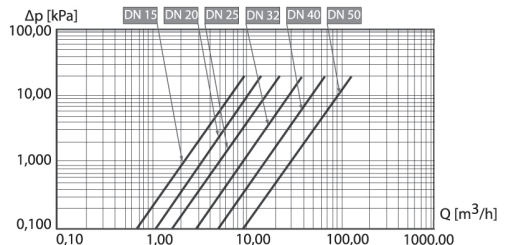

flow rate

Ball valves ONYX

Full-port ball valve with nut on stem and steel lever (female-female version)

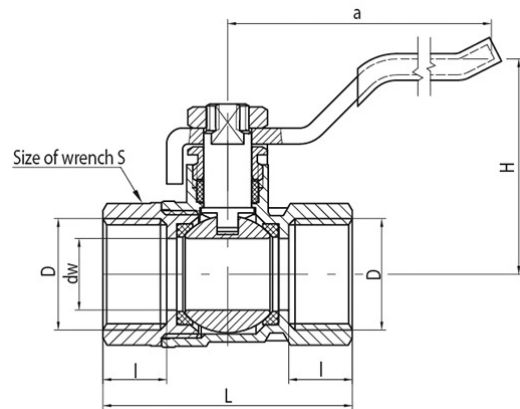

DN	Code	Dimensions								EAN13
		Size	D	l	dw	L	a	H	S	
10	1451320	3/8"	G3/8	10	10	41,5	90	40	21	5907451978054
15	1452320	1/2"	G1/2	12	13,5	47	90	42	25	5907451933145
20	1453320	3/4"	G3/4	12	18,5	55	90	46	31	5907451933213
25	1454320	1"	G1	14,5	23,5	65	110	50	38	5907451933282
32	1455320	1 1/4"	G1 1/4	15	30	75	115,5	65	48	5907451937631
40	1456320	1 1/2"	G1 1/2	16	37	84	140	82,5	54	5907451938058
50	1457320	2"	G2	18	47	100	140	90	67	5907451938096

Product usage:

In the water supply systems for hot and cold water, heating systems, solar systems with glycol water solution as shut-off valves to open and close the flow.

Type:

Straight ball valves

Technical data/Operating parameters:

Max pressure:
 DN10 - DN25: 4 MPa
 DN32 - DN50: 3 MPa
 Max temperature: 180°C

Guarantee:

25-year

Used materials:

body, nut, ball, stem, adjustable stem nut: brass;
 ball and stem seal: PTFE (teflon);
 lever: carbon steel with plastic coating

Finish:

body, nut: nickel; ball: chrome